

Specification sheet

REV.3

Lithe 55Gen4 AJ, Colour Square 1.9" Architectural Adjustable Downlight

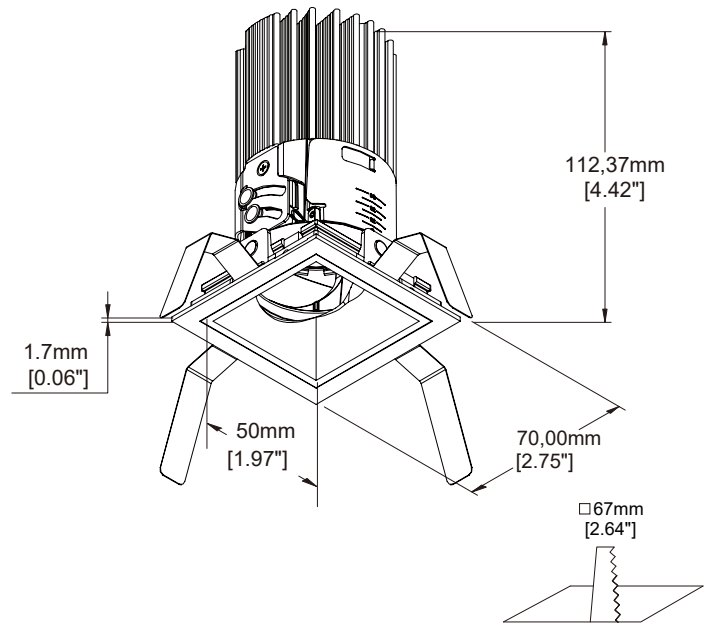

Discription

LTE55G4AJ is MACRON's latest innovation to challenge the physical limitation and strike a balance of aesthetics and performance. LTE55G4AJ is capable of delivering upto 1000 lm and 15-degree tight beam with a remarkable 1.9" (50 mm) aperture and 40-degree light cutoff. Innovative finger-tilt and -rotation mechanism provides a sweat-free adjustment experience. Central beam feature provides the most efficient light output at the exceptional 30-degrees tilt. Mini-flange design provides best visual-integration to the interior design, and option for flangeless application is also available. LTE55G4AJ is a singular recessed adjustable downlight loaded with most professional and unmatched features.

Features

LED	Lumiled Luxeon Cx Plus
Color temperature	2700K/ 3000K/ 3500K/ 4000K
Optics	Spot 15° / Medium 22° / Wide 30°
Trim Finishes	Black / White / Dark Blue / Haze / Gold
Trim Style	Angle Cut /Beve
Ceiling Cutont	∅ 67mm [2.64"]

Performance

Delivered output	1074 lm (90+ CRI)
Power consumption	16 W
Color rendering	90+CRI
Color consistency	3 SDCM
CBCP	Spot 7960cd/ Medium 5503 cd/ Wide 3419cd/
Lumen maintenance	L80 B10 50,000 hrs

Electrical and Control

Input voltage	36vdc
Input Current	450mA Max
Feature	Thermal protector

Construction

Material	Machining grade Aluminum
Trim shape	Square
Lens	Interchangeable TIR optics

Rating/ Certification/ Warranty

- Dry and damp Locations
- RoHS compliant
- 5 years/ 50,000 hrs warranty

Ordering Code Information

	PRODUCT	FLANGE STYLE	FLANGE COLOR	COLOR TEMP.	BEAM ANGLE	COLOR RENDERING
LIGHTING FIXTURE	LTE55G4AJ	RF	WH	27	S	9
	LTE55Gen4 Adjustable	RF Round Flange RL Round Flangeless SF Square Flange SL Square Flangeless	WH White BK Black	27 (2700K) 30 (3000K) 35 (3500K) 40 (4000K)	S Spot / 15deg. M Medium / 22 deg. W Wide / 30 deg.	9 90+CRI
	PRODUCT	TRIM STYLE	TRIM SHAPE	TRIM COLOR		
TRIM	LTE55 TR	BV	SQ	WHGD		
	LTE 55 Trim	BV Bevel AC Angle Cut	RD Round SQ Square	WH White WHBK White \ Black WHGD White \ Gold WHBL White \ Dark Blue WHCE White \ Matt Grey	BK Black BKGD Black \ Gold BKBL Black \ Blue BKCE Black \ Matt Grey	

Photometrics

MULTIPLYING FACTORS: (Multiplying Factor is based on 3000K-90+ CRI IES file on website)

CCT	2700K-80+	3000K-80+	3500K-80+	4000K-80+
Factors	1.12	1.18	1.20	1.25

CCT	2700K-90+	3000K-90+	3500K-90+	4000K-90+
Factors	0.93	1.0	1.06	1.09

Photometrics

Square | 16W | 90CRI | 3000K | Deep Bevel Trim

Tilt 0 deg.

Spot 15°

Delivered Ourput : 993 lm | CBCP : 7960 cd | Beam Angle : 15°

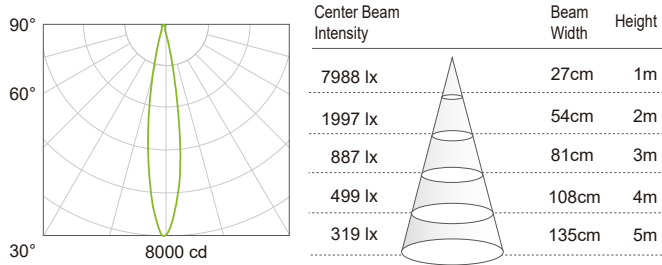

Medium 22°

Delivered Ourput : 1048 lm | CBCP : 5503 cd | Beam Angle : 22°

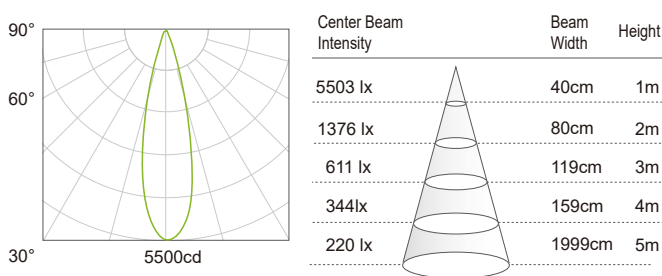

Wide 30°

Delivered Ourput : 1074lm | CBCP : 3419 cd | Beam Angle : 30°

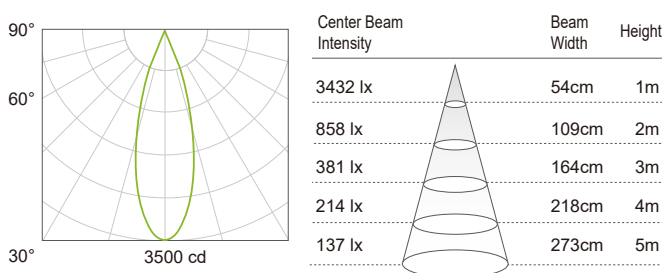

Tilt 15 deg.

Spot 15°

Delivered Ourput : 851 lm

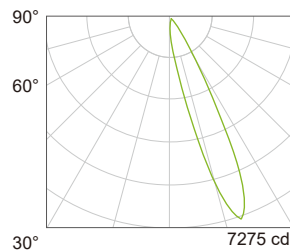

Medium 22°

Delivered Ourput : 936 lm

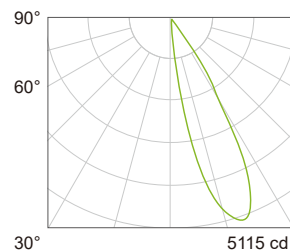

Wide 30°

Delivered Ourput : 991 lm

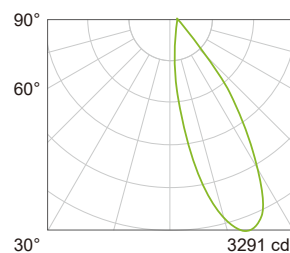

Tilt 30 deg.

Spot 15°

Delivered Ourput : 767 lm

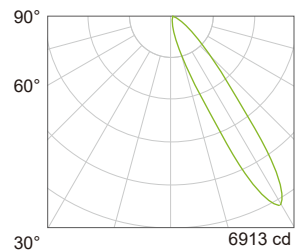

Medium 22°

Delivered Ourput : 854 lm

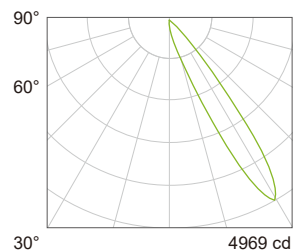

Wide 30°

Delivered Ourput : 919 lm

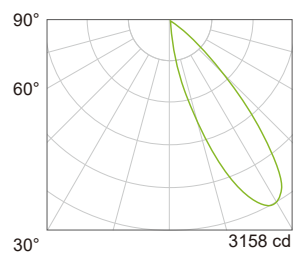

Optional Accessory

PRODUCT	ACC.	
LTE 55	HCL	
LTE 55	HCL Honey Comb Louver	